

Data Sheet | Item Number: 221-485

Splicing connector with levers; for all conductor types; for Ex e applications; max. 4 mm²; 5-conductor; transparent housing; Operating temperature (max.): 105 °C; 4,00 mm²; transparent



<https://www.wago.com/221-485>



Color: transparent



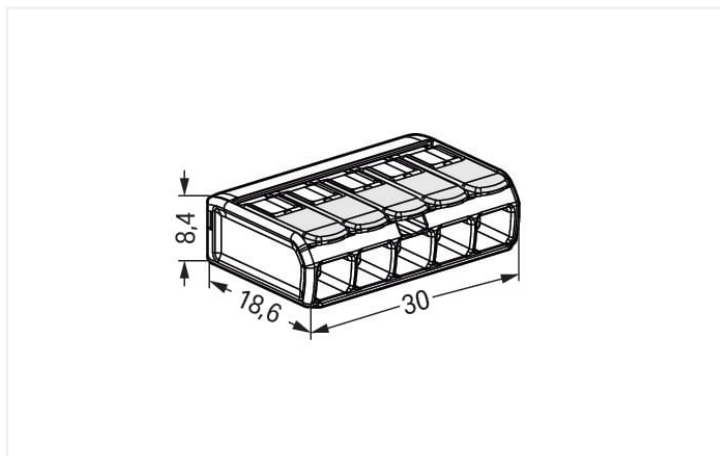

Dimensions in mm

Your benefits:

- Ease of use – pull the lever up, insert a conductor and push the lever back down
- Available as 2-, 3- and 5-wire connectors
- Easily terminate conductors from 0.14 to 4 mm²
- Connect solid, stranded and fine-stranded conductors
- Save time for installers and device manufacturers
- Quickly install devices with higher power consumption
- Safely install long cable runs with larger conductor cross sections
- Mounting carrier for installation conforms to standards
- Working voltages of 275 V or 440 V
- Custom carriers are possible
- ATEX (Ex 2 II G), IECEx (Ex eb IIC Gb) Zone 1, 2
- IECEX (Ex eb IIC Gb), American Ex (AEx eb IICGb) / Class 1, Zone 1

Notes	
Safety management note	<p>NOTICE: Observe installation and safety instructions!</p> <ul style="list-style-type: none"> • Only to be used by electricians! • Do not work under voltage/load! • Use only for proper use! • Observe national regulations/standards/guidelines! • Observe technical specifications for the products! • Observe the number of permissible potentials! • Do not use damaged/dirty components! • Observe conductor types, cross-sections and strip lengths! • Insert conductor until it hits the product's backstop! • Use original accessories! <p>To be sold only with installation instructions!</p>
Safety Information	<p>The permissible operating voltage of the connector with carrier (440 V or 275 V) depends on the mounting type.</p>
Safety information 2	<p>Only approved in conjunction with a mounting carrier (221-501). Other carriers are possible, see certificate/file. The connectors must be installed in an enclosure meeting the requirements of a recognized protection type per EN 60079-0, GB/T 3836.1 Section 1 or EN 60079-31, GB/T 3836.31. When installing the connectors in an enclosure of protection type "e" (increased safety per EN 60079-7, GB/T 3836.3), the clearances and creepage distances of Table 2 for this standard must be observed. See point 1 for the use of accessories. The connectors can be used both in Group II and Group I, as the standard requirements are identical in this case.</p> <p>The use of these components requires a new assessment by a notified certification agency.</p>

Electrical data

Approvals per

UL 60079

	B	C	D
Use group	B	C	D
Rated voltage	-	440 V	-
Rated current	-	20 A	-

Ex information

Ratings per	ATEX: PTB 18 ATEX 1019 U / IECEx: PTB 18.0045U (Ex eb IIC Gb)
Rated voltage EN (Ex e II)	440 V
Rated current (Ex e II)	32 A

Connection data

Clamping units	5
Total number of potentials	1

Connection 1

Connection technology	CAGE CLAMP®
Actuation type	Lever
Connectable conductor materials	Copper
Nominal cross-section	4 mm ² / 12 AWG
Solid conductor	0.2 ... 4 mm ² / 24 ... 12 AWG
Stranded conductor	0.2 ... 4 mm ² / 24 ... 12 AWG
Fine-stranded conductor	0.14 ... 4 mm ² / 24 ... 12 AWG
Strip length	11 mm / 0.43 inches
Wiring direction	Side-entry wiring

Physical data

Width	30 mm / 1.181 inches
Height	8.4 mm / 0.327 inches
Depth	18.6 mm / 0.732 inches

Material data

Note (material data)	Information on material specifications can be found here
Color	transparent
Material group	Illa
Insulation material (main housing)	Polycarbonate (PC)
Flammability class per UL94	V2
Fire load	0.089 MJ
Actuator color	light gray
Weight	4.4 g

Environmental requirements

Ambient temperature (storage)	-40 ... +60 °C
Continuous operating temperature	-55 ... +105 °C

Commercial data

eCl@ss 10.0	27-14-11-04
eCl@ss 9.0	27-14-11-04
ETIM 9.0	EC000446
ETIM 8.0	EC000446
PU (SPU)	250 (25) pcs
Packaging type	Box
Country of origin	DE
GTIN	4055143837330
Customs tariff number	85369010000

Environmental Product Compliance

RoHS Compliance Status

Compliant, No Exemption

Approvals / Certificates

General approvals



Approval	Standard	Certificate Name
----------	----------	------------------

CCA DEKRA Certification B.V.	EN 60998	NTR NL-7990
cULus_Listed_667F Underwriters Laboratories Inc.	UL 486C	E69654
ENEC 05 DEKRA Certification B.V.	EN 60669, EN 60998	71-127529

Declarations of conformity and manufacturer's declarations

Approval	Standard	Certificate Name
----------	----------	------------------

ATEX-Attestation of Conformity WAGO GmbH & Co. KG	-	-
EU-Declaration of Conformity WAGO GmbH & Co. KG	-	-
UK-Declaration of Conformity WAGO GmbH & Co. KG	-	-

Approvals for marine applications



Approval	Standard	Certificate Name
----------	----------	------------------

LR Lloyds Register	EN 60998	LR22207029TA
-----------------------	----------	--------------

Approvals for hazardous areas



Approval	Standard	Certificate Name
----------	----------	------------------

AEx Underwriters Laboratories Inc.	UL 60079	E185892 (AEx eb IIC resp. Ex eb IIC)
ATEX Physikalisch Technische Bundesanstalt	EN IEC 60079-0	PTB 18 ATEX 1019 U (II 2 G Ex eb IIC Gb, I M 2 Ex eb I Mb)
CCC CNEX	GB/T 3836.3	2020312313000184 (Ex eb IIC Gb, Ex eb I Mb)
EAC Brjansker Zertifizierungsstelle	TP TC 012/2011	RU C-DE.AM02. B.00127/19 (Ex e IIC Gb U)
IECEX Physikalisch Technische Bundesanstalt	IEC 60079-0	IECEX PTB 18.0045U (Ex eb IIC Gb, Ex eb I Mb)
INMETRO TÜV Rheinland do Brasil Ltda.	IEC 60079	TÜV 19.1781 U

Downloads

Environmental Product Compliance

Compliance Search

Environmental Product
Compliance 221-485



Documentation

System Description

System Description 221-482, 221-483, 221-485	pdf 1151.51 KB	↓
--	-------------------	-------------------

Bid Text

221-485	21.05.2019	xml 4.09 KB	↓
221-485	21.05.2019	docx 16.02 KB	↓
ausschreiben.de 221-485			↓

CAD/CAE-Data

CAD data

2D/3D Models 221-485	↓
----------------------	-------------------

CAE data

EPLAN Data Portal 221-485	↓
ZUKEN Portal 221-485	↓

1 Compatible Products

1.1 Optional Accessories

1.1.1 Mounting adapter

1.1.1.1 Mounting accessories



Item No.: 221-500/000-006

Mounting carrier; 221 Series - 4 mm²; for DIN-35 rail mounting/screw mounting; blue

Item No.: 221-501

Mounting carrier; for Ex applications; 221 Series - 4 mm²; for DIN-35 rail mounting/screw mounting; light gray

Installation Notes

Conductor termination

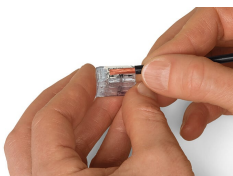

Strip conductor to 11 mm (0.43 inch).

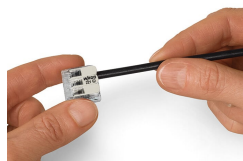

Then, lower the lever to close the clamp.

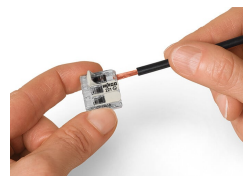

Termination: Lift the lever to open the clamping unit and insert a stripped conductor.

Installation

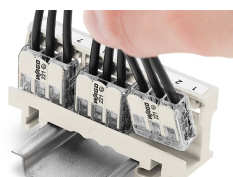

Inserting a connector into the mounting carrier.

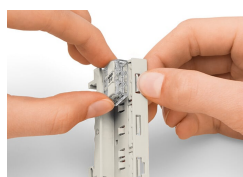

Removing a connector from the mounting carrier.



Removing a conductor.

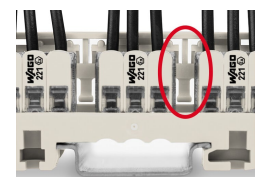

Mounting type (440 V)
Using spacers between the connectors.

Installation



Mounting type (440 V)

Vertical mounting on DIN-35 rail

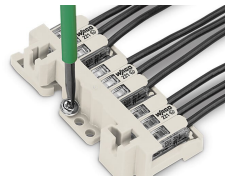

Mounting type (440 V)

Horizontal screw mounting on a flat surface



Mounting type (440 V)

Mounting the carrier via non-conductive screws.

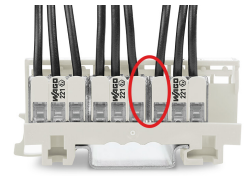

Mounting type (275 V)

No spacers are used between the connectors.

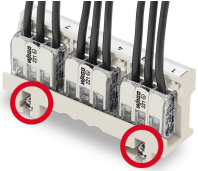

Mounting type (275 V)

Mounting the carrier using conductive screws.

Testing

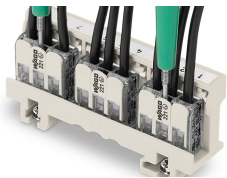

Easily test inserted connectors in the carrier – however they are mounted.