

Data Sheet | Item Number: 765-4204/100-000

4-Port IO-Link Master Class B; EtherCAT; DC 24 V / 2.0 A; 4xM12 connection; Slim-Line

<https://www.wago.com/765-4204/100-000>

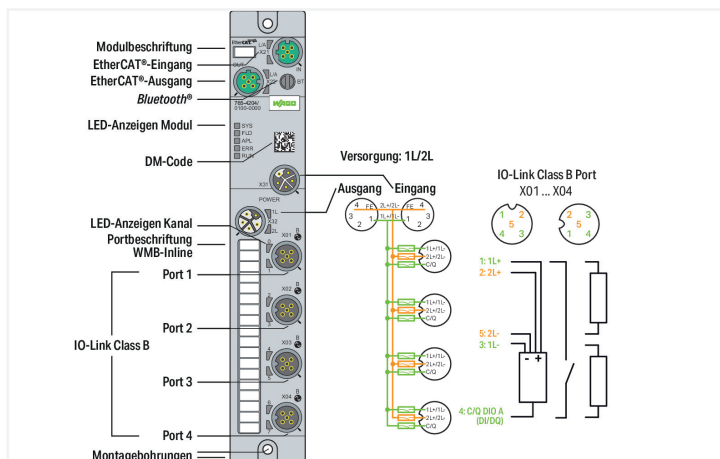

Application area:

Decentralized processing of digital and IO-Link signals

This device controls IO-Link-capable digital field devices (e.g., actuators and hubs) and records digital signals from IO-Link-capable field devices (e.g., sensors and hubs) that are sent or received by a higher-level controller.

The device is designed as a Class B master and offers 4 IO-Link ports or 4 digital inputs/outputs.

IO-Link:

The device has several IO-Link communication interfaces for interoperation with IO-Link devices.

The IO-Link interface enables direct access to the process and diagnostic data and allows the parameters of the connected devices to be set during operation.

The IODD can also be downloaded via IODDfinder (<https://ioddfinder.io-link.com>).

Technical data

Fieldbus		Device functions	
Communications	EtherCAT® AoE, EoE, FoE	Parameter	Input filter Output current Temperature
Connection technology: communication/ fieldbus	2 x D-coded M12; 4-pole	Diagnostics	Undervoltage; overcurrent; overload; overtemperature
Interface standard	10BASE-T/100BASE-TX; potential-free	Device functions	Bluetooth® OPC UA server
Autonegotiation; autocrossover	Yes	Visualization	Android/iOS app Web server

IO-Link master

IO-Link master classification	Class B; V1.1 specification
Port-Modus	IO-Link: autoconfig, manual, tool-based DI DO
Cycle time	400 µs (min.)
Operating mode	IO-Link master, DI or DO (adjustable for pin 4 per port); Supply voltage 2L (fixed for pin 2 per port)

IO-Link ports

Number of digital inputs	4
Number of digital outputs	4
Connection technology: inputs/outputs	4 x A-coded M12; 5-pole
Signal type (voltage)	24 VDC
Input characteristic	high-side switching Type 3, per IEC 61131-2
Input filter	0.2 ... 20 ms
Output current (per channel)	2 A (typ.) for DO
Supply current per port	1L (Pin 1): 1 A for IO-Link; 4 A (max.) for DIO; 2L (Pin 2): 4 A (max.)

Supply (module)

Connection technology: supply	2 x L-coded M12; 5-pole
Supply voltage	24 VDC (18 ... 31.2 V); 1L/2L
Current consumption (max.)	16000 mA
Current consumption (note)	per supply line; overload- and short-cir- cuit-protected
Reverse voltage protection	Yes

Physical data

Width	35 mm / 1.378 inches
Height	30 mm / 1.181 inches
Depth	210 mm / 8.268 inches

Mechanical data

Weight	380 g
Conformity marking	CE

Environmental requirements

Ambient temperature (operation)	-25 ... +70 °C
Ambient temperature (storage)	-40 ... +80 °C
Protection type	IP67
Protection class	III per EN 61140, IEC 61140, VDE 0140-1
Operating altitude	0 ... 2000 m / 0 ... 6562 ft
Pollution degree	3 (EN 60664-1)
Overvoltage category	II (EN 60664-1)
Relative humidity (without condensation)	95 %
Vibration resistance	5g per IEC 60068-2-6
Shock resistance	Short-term: 50g/11 ms/half-sine per IEC 60068-2-27; Long-term: 30g/6 ms/half-sine per IEC 60068-2-29
EMC immunity to interference	per EN 61000-6-2

Environmental requirements

EMC emission of interference	per EN 61000-6-4
------------------------------	------------------

Commercial data

ETIM 9.0	EC001601
ETIM 8.0	EC001601
PU (SPU)	1 pcs
Packaging type	Box
Country of origin	DE
GTIN	4066966063172
Customs tariff number	85371098990

Environmental Product Compliance

RoHS Compliance Status	Compliant, No Exemption
------------------------	-------------------------

Approvals / Certificates

General approvals



Approval	Standard	Certificate Name
EAC GZO Almaty Standart	TP TC 020/2011	EAC CoC 03083
KC National Radio Research Agency	Article 58-2, Clause 3	KC R-R-W43-FB765
UL Underwriters Laboratories Inc. (ORDINARY LOCATIONS)	-	E175199

Downloads

Environmental Product Compliance

Compliance Search	
Environmental Product Compliance 765-4204/100-000	↓

Documentation

Manual	System Description
Product Manual 4-Port-IO Link Master Class B; EtherCAT; 24 VDC / 2.0 A; V 2.0.0 19.07.2022 pdf 8086.70 KB ↓	WAGO I/O System Field; General Product Information pdf 1009.23 KB ↓

Instruction Leaflet			
I/O System Field package insert	15.12.2021	pdf 1083.98 KB	↓

Application Notes

Application Note e!COCKPIT			
e!COCKPIT Application	1.0.0	pptx	↓
Note EtherCAT IO-Field (a2022003)	23.03.2023	2143.63 KB	↓

CAD/CAE-Data

CAD data	
2D/3D Models 765-4204/100-000	↓

CAE data	
EPLAN Data Portal 765-4204/100-000	↓

Runtime Software

Firmware			
0765-x2xx, EtherCat IO-Field	V 04 02.02.2023	zip 1582.68 KB	↓

Libraries

Device Description File			
Gerätebeschreibungsdateien 765-42xx, 765-12xx, EtherCAT	V1_1_0_22	zip 75.78 KB	↓

1 Compatible Products

1.1 Required Accessories

1.1.1 Cover

1.1.1.1 Cover



[Item No.: 756-8103](#)
M12 protective cap; for unused plugs

[Item No.: 756-8102](#)
M12 protective cap; for unused sockets

1.1.2 Marking

1.1.2.1 Marker



Item No.: 2009-115

WMB-Inline; for Smart Printer; 1500 pieces on roll; stretchable 5 - 5.2 mm; plain; snap-on type; white

1.1.2.2 Marking strip



Item No.: 2009-110

Marking strips; for Smart Printer; on reel; not stretchable; plain; snap-on type; white

1.1.3 Tool

1.1.3.1 Assembly tool



Item No.: 206-701

Torque wrench M8 and M12; Assembly kit

1.2 Optional Accessories

1.2.1 Cables and connectors

1.2.1.1 Configurable Connector



Item No.: 756-9701/050-000

Fitted pluggable connector; 5-pole, shielded; M12 plug, straight; IDC technology



Item No.: 756-9711/050-000

Fitted pluggable connector; 5-pole, shielded; M12 socket, straight; IDC technology



Item No.: 756-9205/050-000

Fitted pluggable connector; 5-pole; M12 plug, right angle; Spring



Item No.: 756-9202/050-000

Fitted pluggable connector; 5-pole; M12 plug, straight, A-coded; Spring

1.2.1.2 Configurable Shielded Connector



Item No.: 756-9501/040-000

Accessories; M12 plug, right angle; 4-pole



Item No.: 756-9501/060-000

Fitted pluggable connector; 4-pole, shielded; M12 plug, straight, D-coded; Spring



















1.2.1.3 Distribution connector































Item No.: 756-9301/050-000

Accessories; 5-pole

1.2.1.4 ETHERNET/PROFINET cable

 Item No.: 756-1202/060-100 ETHERNET cable; M12D plug; angled; 4-pole; Length: 10 m	 Item No.: 756-1202/060-020 ETHERNET cable; M12D plug; angled; 4-pole; Length: 2 m	 Item No.: 756-1202/060-200 ETHERNET cable; M12D plug; angled; 4-pole; Length: 20 m	 Item No.: 756-1202/060-050 ETHERNET cable; M12D plug; angled; 4-pole; Length: 5 m
 Item No.: 756-1204/060-010 ETHERNET cable; M12D plug; angled; M12D plug; angled; 4-pole; Length: 1 m	 Item No.: 756-1204/060-100 ETHERNET cable; M12D plug; angled; M12D plug; angled; 4-pole; Length: 10 m	 Item No.: 756-1204/060-020 ETHERNET cable; M12D plug; angled; M12D plug; angled; 4-pole; Length: 2 m	 Item No.: 756-1204/060-200 ETHERNET cable; M12D plug; angled; M12D plug; angled; 4-pole; Length: 20 m
 Item No.: 756-1204/060-030 ETHERNET cable; M12D plug; angled; M12D plug; angled; 4-pole; Length: 3 m	 Item No.: 756-1204/060-050 ETHERNET cable; M12D plug; angled; M12D plug; angled; 4-pole; Length: 5 m	 Item No.: 756-1201/060-100 ETHERNET cable; M12D plug; straight; 4-pole; Length: 10 m	 Item No.: 756-1201/060-020 ETHERNET cable; M12D plug; straight; 4-pole; Length: 2 m
 Item No.: 756-1201/060-200 ETHERNET cable; M12D plug; straight; 4-pole; Length: 20 m	 Item No.: 756-1201/060-050 ETHERNET cable; M12D plug; straight; 4-pole; Length: 5 m	 Item No.: 756-1203/060-100 ETHERNET cable; M12D plug; straight; M12D plug; straight; 4-pole; Length: 10 m	 Item No.: 756-1203/060-020 ETHERNET cable; M12D plug; straight; M12D plug; straight; 4-pole; Length: 2 m
 Item No.: 756-1203/060-200 ETHERNET cable; M12D plug; straight; M12D plug; straight; 4-pole; Length: 20 m	 Item No.: 756-1203/060-050 ETHERNET cable; M12D plug; straight; M12D plug; straight; 4-pole; Length: 5 m		

1.2.1.5 Power cable

 Item No.: 756-3504/050-100 Power cable; M12L plug; angled; 5-pole; Length: 10 m	 Item No.: 756-3514/050-100 Power cable; M12L plug; angled; 5-pole; Length: 10 m	 Item No.: 756-3504/050-150 Power cable; M12L plug; angled; 5-pole; Length: 15 m	 Item No.: 756-3514/050-150 Power cable; M12L plug; angled; 5-pole; Length: 15 m
 Item No.: 756-3504/050-020 Power cable; M12L plug; angled; 5-pole; Length: 2 m	 Item No.: 756-3504/050-050 Power cable; M12L plug; angled; 5-pole; Length: 5 m	 Item No.: 756-3514/050-050 Power cable; M12L plug; angled; 5-pole; Length: 5 m	 Item No.: 756-3504/050-075 Power cable; M12L plug; angled; 5-pole; Length: 7.5 m
 Item No.: 756-3514/050-075 Power cable; M12L plug; angled; 5-pole; Length: 7.5 m	 Item No.: 756-3503/050-100 Power cable; M12L plug; straight; 5-pole; Length: 10 m	 Item No.: 756-3513/050-100 Power cable; M12L plug; straight; 5-pole; Length: 10 m	 Item No.: 756-3503/050-150 Power cable; M12L plug; straight; 5-pole; Length: 15 m
 Item No.: 756-3513/050-150 Power cable; M12L plug; straight; 5-pole; Length: 15 m	 Item No.: 756-3503/050-020 Power cable; M12L plug; straight; 5-pole; Length: 2 m	 Item No.: 756-3513/050-020 Power cable; M12L plug; straight; 5-pole; Length: 2 m	 Item No.: 756-3503/050-050 Power cable; M12L plug; straight; 5-pole; Length: 5 m
 Item No.: 756-3513/050-050 Power cable; M12L plug; straight; 5-pole; Length: 5 m	 Item No.: 756-3503/050-075 Power cable; M12L plug; straight; 5-pole; Length: 7.5 m	 Item No.: 756-3513/050-075 Power cable; M12L plug; straight; 5-pole; Length: 7.5 m	 Item No.: 756-3502/050-100 Power cable; M12L socket; angled; 5-pole; Length: 10 m
 Item No.: 756-3512/050-100 Power cable; M12L socket; angled; 5-pole; Length: 10 m	 Item No.: 756-3502/050-150 Power cable; M12L socket; angled; 5-pole; Length: 15 m	 Item No.: 756-3512/050-150 Power cable; M12L socket; angled; 5-pole; Length: 15 m	 Item No.: 756-3502/050-020 Power cable; M12L socket; angled; 5-pole; Length: 2 m
 Item No.: 756-3512/050-020 Power cable; M12L socket; angled; 5-pole; Length: 2 m	 Item No.: 756-3502/050-050 Power cable; M12L socket; angled; 5-pole; Length: 5 m	 Item No.: 756-3512/050-050 Power cable; M12L socket; angled; 5-pole; Length: 5 m	 Item No.: 756-3502/050-075 Power cable; M12L socket; angled; 5-pole; Length: 7.5 m

1.2.1.5 Power cable



Item No.: 756-3512/050-075

Power cable; M12L socket; angled; 5-pole; Length: 7.5 m

Item No.: 756-3506/050-003

Power cable; M12L socket; angled; M12L plug; angled; 5-pole; Length: 0.3 m

Item No.: 756-3506/050-005

Power cable; M12L socket; angled; M12L plug; angled; 5-pole; Length: 0.5 m

Item No.: 756-3516/050-005

Power cable; M12L socket; angled; M12L plug; angled; 5-pole; Length: 0.5 m



Item No.: 756-3506/050-010

Power cable; M12L socket; angled; M12L plug; angled; 5-pole; Length: 1 m

Item No.: 756-3516/050-010

Power cable; M12L socket; angled; M12L plug; angled; 5-pole; Length: 1 m

Item No.: 756-3506/050-100

Power cable; M12L socket; angled; M12L plug; angled; 5-pole; Length: 10 m

Item No.: 756-3516/050-100

Power cable; M12L socket; angled; M12L plug; angled; 5-pole; Length: 10 m



Item No.: 756-3506/050-150

Power cable; M12L socket; angled; M12L plug; angled; 5-pole; Length: 15 m

Item No.: 756-3506/050-020

Power cable; M12L socket; angled; M12L plug; angled; 5-pole; Length: 2 m

Item No.: 756-3516/050-020

Power cable; M12L socket; angled; M12L plug; angled; 5-pole; Length: 2 m

Item No.: 756-3516/050-200

Power cable; M12L socket; angled; M12L plug; angled; 5-pole; Length: 20 m



Item No.: 756-3516/050-400

Power cable; M12L socket; angled; M12L plug; angled; 5-pole; Length: 40 m

Item No.: 756-3506/050-050

Power cable; M12L socket; angled; M12L plug; angled; 5-pole; Length: 5 m

Item No.: 756-3516/050-050

Power cable; M12L socket; angled; M12L plug; angled; 5-pole; Length: 5 m

Item No.: 756-3506/050-075

Power cable; M12L socket; angled; M12L plug; angled; 5-pole; Length: 7.5 m



Item No.: 756-3516/050-075

Power cable; M12L socket; angled; M12L plug; angled; 5-pole; Length: 7.5 m

Item No.: 756-3501/050-100

Power cable; M12L socket; straight; 5-pole; Length: 10 m

Item No.: 756-3511/050-100

Power cable; M12L socket; straight; 5-pole; Length: 10 m

Item No.: 756-3501/050-150

Power cable; M12L socket; straight; 5-pole; Length: 15 m



Item No.: 756-3511/050-150

Power cable; M12L socket; straight; 5-pole; Length: 15 m

Item No.: 756-3501/050-020

Power cable; M12L socket; straight; 5-pole; Length: 2 m

Item No.: 756-3511/050-020

Power cable; M12L socket; straight; 5-pole; Length: 2 m

Item No.: 756-3501/050-050

Power cable; M12L socket; straight; 5-pole; Length: 5 m



Item No.: 756-3511/050-050

Power cable; M12L socket; straight; 5-pole; Length: 5 m

Item No.: 756-3501/050-075

Power cable; M12L socket; straight; 5-pole; Length: 7.5 m

Item No.: 756-3511/050-075

Power cable; M12L socket; straight; 5-pole; Length: 7.5 m

Item No.: 756-3505/050-003

Power cable; M12L socket; straight; M12L plug; straight; 5-pole; Length: 0.3 m



Item No.: 756-3505/050-005

Power cable; M12L socket; straight; M12L plug; straight; 5-pole; Length: 0.5 m

Item No.: 756-3515/050-005

Power cable; M12L socket; straight; M12L plug; straight; 5-pole; Length: 0.5 m

Item No.: 756-3505/050-010

Power cable; M12L socket; straight; M12L plug; straight; 5-pole; Length: 1 m

Item No.: 756-3515/050-010

Power cable; M12L socket; straight; M12L plug; straight; 5-pole; Length: 1 m



Item No.: 756-3505/050-100

Power cable; M12L socket; straight; M12L plug; straight; 5-pole; Length: 10 m

Item No.: 756-3515/050-100

Power cable; M12L socket; straight; M12L plug; straight; 5-pole; Length: 10 m

Item No.: 756-3505/050-150

Power cable; M12L socket; straight; M12L plug; straight; 5-pole; Length: 15 m

Item No.: 756-3505/050-020

Power cable; M12L socket; straight; M12L plug; straight; 5-pole; Length: 2 m



Item No.: 756-3515/050-020

Power cable; M12L socket; straight; M12L plug; straight; 5-pole; Length: 2 m

Item No.: 756-3515/050-200

Power cable; M12L socket; straight; M12L plug; straight; 5-pole; Length: 20 m

Item No.: 756-3515/050-300

Power cable; M12L socket; straight; M12L plug; straight; 5-pole; Length: 30 m

Item No.: 756-3515/050-400

Power cable; M12L socket; straight; M12L plug; straight; 5-pole; Length: 40 m



Item No.: 756-3505/050-050

Power cable; M12L socket; straight; M12L plug; straight; 5-pole; Length: 5 m

Item No.: 756-3515/050-050

Power cable; M12L socket; straight; M12L plug; straight; 5-pole; Length: 5 m

Item No.: 756-3505/050-075

Power cable; M12L socket; straight; M12L plug; straight; 5-pole; Length: 7.5 m

Item No.: 756-3515/050-075

Power cable; M12L socket; straight; M12L plug; straight; 5-pole; Length: 7.5 m

1.2.1.6 Sensor/actuator cable



Item No.: 756-5312/050-015
Sensor/Actuator cable; M12A plug; angled; 5-pole; Length: 1.5 m



Item No.: 756-5312/050-100
Sensor/Actuator cable; M12A plug; angled; 5-pole; Length: 10 m



Item No.: 756-5312/050-050
Sensor/Actuator cable; M12A plug; angled; 5-pole; Length: 5 m



Item No.: 756-5311/050-015
Sensor/Actuator cable; M12A plug; straight; 5-pole; Length: 1.5 m



Item No.: 756-5311/050-100
Sensor/Actuator cable; M12A plug; straight; 5-pole; Length: 10 m



Item No.: 756-5311/050-050
Sensor/Actuator cable; M12A plug; straight; 5-pole; Length: 5 m



Item No.: 756-5404/050-010
Sensor/Actuator cable; M12A socket; angled; M12A plug; angled; 5-pole; Length: 1 m



Item No.: 756-5404/050-020
Sensor/Actuator cable; M12A socket; angled; M12A plug; angled; 5-pole; Length: 2 m



Item No.: 756-5403/050-010
Sensor/Actuator cable; M12A socket; angled; M12A plug; straight; 5-pole; Length: 1 m



Item No.: 756-5403/050-020
Sensor/Actuator cable; M12A socket; angled; M12A plug; straight; 5-pole; Length: 2 m



Item No.: 756-5402/050-010
Sensor/Actuator cable; M12A socket; straight; M12A plug; angled; 5-pole; Length: 1 m



Item No.: 756-5402/050-020
Sensor/Actuator cable; M12A socket; straight; M12A plug; angled; 5-pole; Length: 2 m



Item No.: 756-5401/050-010
Sensor/Actuator cable; M12A socket; straight; M12A plug; straight; 5-pole; Length: 1 m



Item No.: 756-5401/050-020
Sensor/Actuator cable; M12A socket; straight; M12A plug; straight; 5-pole; Length: 2 m