

## Data sheet

Commercial Art.No.: R1.450.9324.0

encoder cable SAFE HTL ENCODER CABLE-M23CKW-PUR-070

Encoder cable, 7 m, Head A:M23, 12 pins, Clockwise connector, Counter-C lockwise wiring, Cable:PUR, shielded, M23, 12 pins, Counter-Clockwise wiring, Head B: free end



Commercial Art.No.	R1.450.9324.0
EAN	4049088522055
Order Unit	1

## Technical data

### classification

ECLASS 11	
ECLASS 8.1	27249205
ETIM 9.0	EC000237
ETIM 8.0	
ETIM 7.0	
ETIM 6.0	
ETIM 5.0	EC000237
ETIM 4.0	EC000237

### product compliance

ROHS conformity status	compliant
REACH-SVHC conformity status	compliant

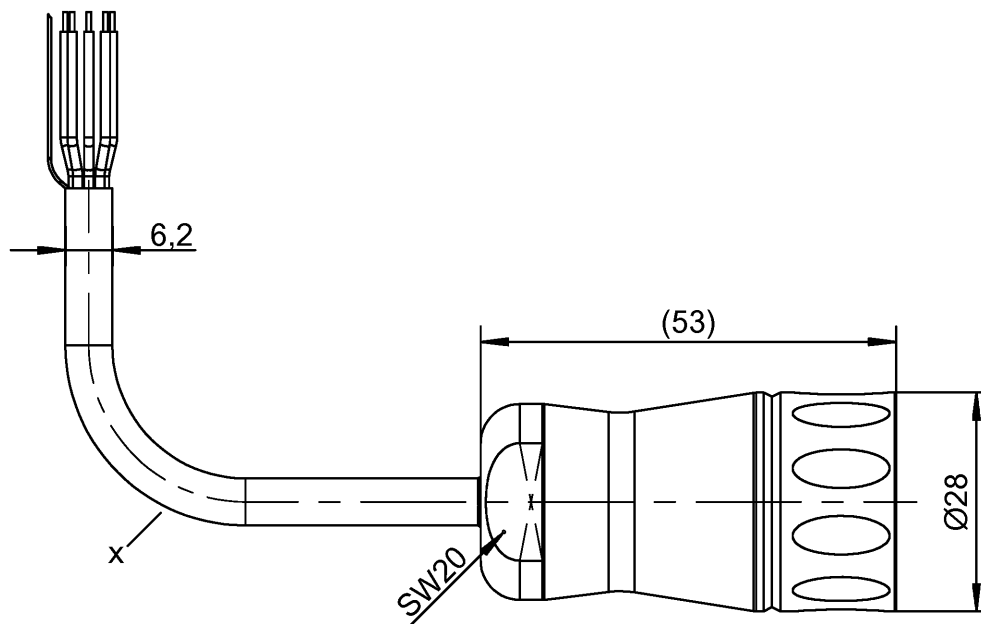



Qu - PEE 12/92

Teile-Nr. / Part No.	Typ / Type	X= Laenge / Length
R1.450.9310.0	CABLE-M23CKW-PUR-015	1,5m
R1.450.9314.0	CABLE-M23CKW-PUR-030	3m
R1.450.9320.0	CABLE-M23CKW-PUR-050	5m
R1.450.9324.0	CABLE-M23CKW-PUR-070	7m
R1.450.9330.0	CABLE-M23CKW-PUR-100	10m
R1.450.9335.0	CABLE-M23CKW-PUR-150	15m
R1.450.9340.0	CABLE-M23CKW-PUR-200	20m

Weitere Angaben siehe KATALOG oder eKatalog.  
Additional data see CATALOG or eCatalog.

[www.wieland-electric.com](http://www.wieland-electric.com)  
[eshop.wieland-electric.com](http://eshop.wieland-electric.com)

ja/yes  Stoffverbots- und Deklarationsliste nach WN 5020.010 ist einzuhalten.  
Conformity with Wieland document WN 5020.010 e (list of prohibited / declarable hazardous substances) to be declared!

Freitoleranz nach General tolerance		CAD-Zeichnung, keine manuellen Änderungen CAD-Drawing, no manual modifications allowed			1. Verwendung: First Use:		Blatt: Sheet:		
 Maßstab/Scale		Werkstoff/ Material		2018	Tag/ Date	Name		Zeichnung Nr./ Drawing No.	
				gezeichnet drawn	13.12.	Koetzner		<b>T R1.450.9310.0 01K</b> Maße in mm/Dimensions are in mm	
				geprüft checked					
				Normgepr. Stand. check					
Datei/ File: 046231_01K/R1.450.9310.0.DCD				Ersatz für/ Replacement for:					
				Type		Benennung/ Title		Teilespezifikation / Component specification	
Index		Datum/ Blatt Date/ Sheet		 <b>wieland</b> <a href="http://www.wieland-electric.com">www.wieland-electric.com</a>				SENC - Zubehoer / Accessories	
Änderung/ Revision									