

article#	61232-6
article description	CEE-switched interlocked socket compact 32A 3p 6h IP66/IP67
description long	CEE-switched interlocked socket compact 32A 3p 6h IP66/IP67 housing material: PA6 + PC/ABS rated current: 32A number of poles: 3 (2P+PE) clock-position: 6h rated voltage/frequency: 200-250V~ / 50+60Hz contacts: brass nickel plated connection technology: screw terminals wall mounting, mechanical interlock switch: ON/OFF PCE-Merz ML0; EN 60947-3; AC22A, 10kA IP protection class: IP66/IP67
GTIN (EAN)	9003399174834
country of origin	AT
customs number	85366990
net weight	0.668 kg
packaging quantity	1
minimum order quantity	1

ETIM 9.0	EC001324
IEC-amperage	32 A
Number of poles	3
Voltage according to EN 60309-2	230 V (50+60 Hz) blue
Clock hour position	6 h
Identification colour	Blue
Degree of protection (IP)	IP67
Switch	Mechanical locking
Material housing	Plastic
Model	Base unit and cover
Contact material	CuZn
Surface treatment contacts	Nickel-plated

a	124 mm
wire flexible	2,5-6 mm ²
wire solid	2,5-10 mm ²
contact screws	120 Ncm
housing screws	110 Ncm
ambient temperature	-25 – 40 °C
temperature resistance	-25 – 80 °C
IK-code *)	IK10



*) The IK-test is not part of the IEC 60309 standard for industrial plugs and socket-outlets or the IEC 60884 standard for household plugs and socket-outlets. PC Electric GmbH has therefore tested the IK-codes of these products in accordance with IEC 62262 and according to the test method of IEC 60068-2-75 Ehc, with conditioning for 48 hours at 40°C and a relative humidity of 95%.

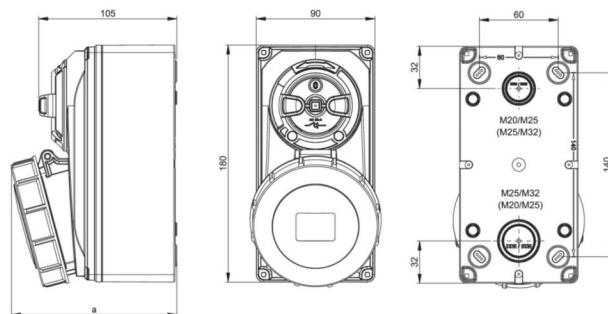

<https://www.pcelectric.at/shop/en/?func=detail&artnr=61232-6>