

article#	<b>4232-6f78</b>
article description	<b>CEE-flanged socket sloping (80x97mm) 32A 3p 6h IP67</b>
description long	CEE-flanged socket sloping (80x97mm) 32A 3p 6h IP67 housing material: PA6 rated current: 32A number of poles: 3 (2P+PE) clock-position: 6h rated voltage/frequency: 200-250V~ / 50+60Hz contacts: brass connection technology: screw terminals dimensions (flange/fixing center): 80x97 mm / 60x73 mm IP protection class: IP67
GTIN (EAN)	9003399599712
country of origin	AT
customs number	85366990
net weight	0.207 kg
packaging quantity	10
minimum order quantity	10

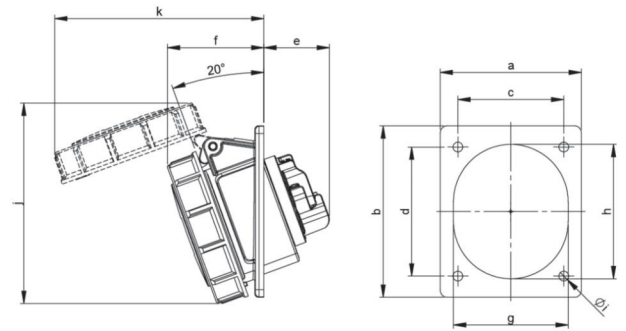

ETIM 9.0	EC001317
IEC-amperage	32 A
Voltage according to EN 60309-2	230 V (50+60 Hz) blue
Number of poles	3
Clock hour position	6 h
Identification colour	Blue
Degree of protection (IP)	IP67
Connection system	Screwed terminal
Angle of plug	Angled
Material	Plastic
Contact material	CuZn
Surface treatment contacts	Untreated
Flange size vertical	97 mm
Drill hole distance vertical	73 mm
Flange size horizontal	80 mm
Drill hole distance horizontal	60 mm



a	80 mm
b	97 mm
c	60 mm
d	73 mm
e	48 mm
f	59 mm
g	65 mm
h	75 mm
i	5,5 mm
j	120 mm
k	127 mm
wire flexible	2,5-6 mm <sup>2</sup>
wire solid	2,5-10 mm <sup>2</sup>
contact screws	110 Ncm
dismantling length	50 mm
stripping length	12-14 mm
ambient temperature	-25 – 40 °C
temperature resistance	-25 – 80 °C



<https://www.pcelectric.at/shop/en/?func=detail&artnr=4232-6f78>

